

Please note that the data given here has been taken from the online catalog. For comprehensive information and data, please refer to the user documentation at <http://www.download.phoenixcontact.com>. The General Terms and Conditions of Use apply to Internet downloads.

▶ Extract from the online catalog

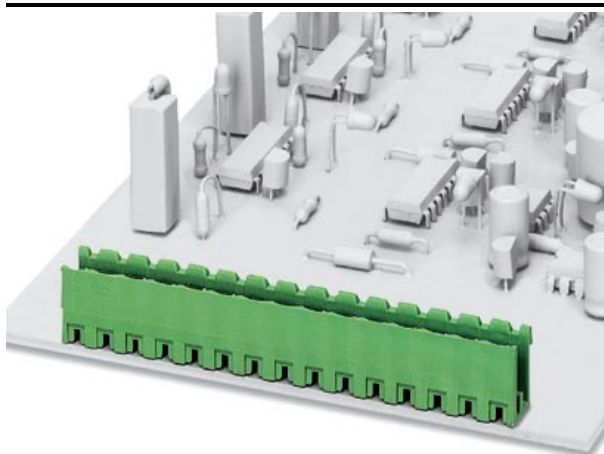

Header, nominal current: 12 A, rated voltage: 250 V,
pitch: 5.08 mm, no. of positions: 8, mounting: Soldering

The illustration shows a 14-position version

Order No.	1758076
Ord designation	MSTBV 2,5/ 8-G-5,08
EAN	4017918030285
Pack	50 Pcs.
Customs tariff	85369010
Catalog page information	Page 168 (CC-2005)

▶ Technical data

Dimensions / positions

Pitch	5.08 mm
Dimension a	35.56 mm
Number of positions	8
Pin dimensions	1 x 1 mm
Hole diameter	1.4 mm

Technical data

Insulating material group	IIIa
Rated surge voltage (III/3)	4 kV
Rated surge voltage (III/2)	4 kV
Rated surge voltage (II/2)	4 kV
Rated voltage (III/2)	320 V
Rated voltage (II/2)	400 V
Connection in acc. with standard	EN-VDE
Nominal current I_N	12 A
Nominal voltage U_N	250 V
Maximum load current	12 A
Insulating material	PBT
Inflammability class acc. to UL 94	V0

► Certificates

Certificate logos



UL

Nominal voltage U_N	300 V
Nominal current I_N	10 A

CSA

Nominal voltage U_N	300 V
Nominal current I_N	10 A

► Drawings

Drilling diagram

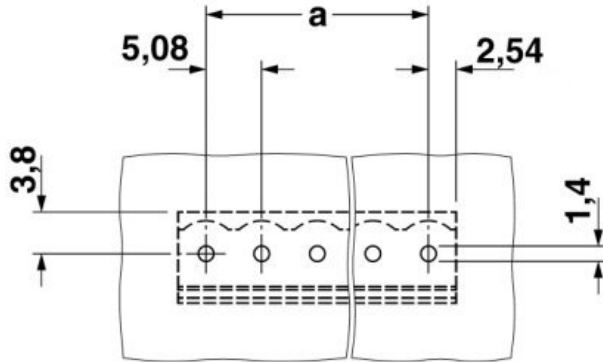

Dimensioned drawing

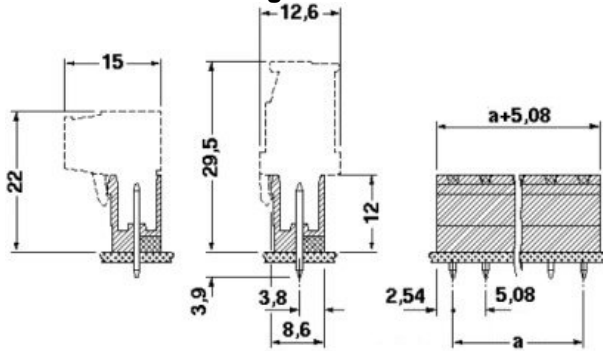

► Accessories

Item	Designation	Description
Assembly		
1755477	MSTB-BL	Keying cap, for forming sections, plugs onto header pin, green insulating material
Marking		
1051993	B-STIFT	Marker pen, for manual labeling of unprinted Zack strips, smear-proof and waterproof, line thickness 0.5 mm
0804293	SK 5,08/3,8:FORTL.ZAHLEN	Marker card, printed horizontally, self-adhesive, 12 identical decades marked 1-10, 11-20 etc. up to 91-(99)100, sufficient for 120 terminal blocks
0805085	SK 5,08/3,8:SO	Marker card, self-adhesive, marking according to customer requirements
0805412	SK 5,08/3,8:UNBEDRUCKT	Marker cards, unprinted, with pitch divisions, self-adhesive, 10-section marker strips, 12 strips per card, can be labeled with M-PEN
Plug/Adapter		
1734401	CR-MSTB	Coding element, inserted into the recess in the header or the inverted plug, red insulating material



► **Additional products**

Item	Designation	Description
------	-------------	-------------

General

1872758	A-ICV 2,5/ 8-G-5,08	Header, nominal current: 12 A, rated voltage: 250 V, pitch: 5.08 mm, no. of positions: 8, mounting: Mounting rail
1873113	FKC 2,5/ 8-ST-5,08	Plug component, nominal current: 12 A, rated voltage: 250 V, pitch: 5.08 mm, no. of positions: 8, type of connection: Spring-cage connection
1902178	FKCT 2,5/ 8-ST-5,08	Plug component, nominal current: 12 A, rated voltage: 250 V, pitch: 5.08 mm, no. of positions: 8, type of connection: Spring-cage connection
1874015	FKCVR 2,5/ 8-ST-5,08	Plug component, nominal current: 12 A, rated voltage: 250 V, pitch: 5.08 mm, no. of positions: 8, type of connection: Spring-cage connection
1873715	FKCVW 2,5/ 8-ST-5,08	Plug component, nominal current: 12 A, rated voltage: 250 V, pitch: 5.08 mm, no. of positions: 8, type of connection: Spring-cage connection
1777345	FRONT-MSTB 2,5/ 8-ST-5,08	Plug component, nominal current: 12 A, rated voltage: 320 V, pitch: 5.08 mm, no. of positions: 8, type of connection: Screw connection
1786462	IC 2,5/ 8-G-5,08	Header, nominal current: 12 A, rated voltage: 250 V, pitch: 5.08 mm, no. of positions: 8, mounting: Soldering
1786006	ICV 2,5/ 8-G-5,08	Header, nominal current: 12 A, rated voltage: 250 V, pitch: 5.08 mm, no. of positions: 8, mounting: Soldering
1757077	MSTB 2,5/ 8-ST-5,08	Plug component, nominal current: 12 A, rated voltage: 250 V, pitch: 5.08 mm, no. of positions: 8, type of connection: Screw connection
1764235	MSTB 2,5/ 8-STZ-5,08	Plug component, nominal current: 12 A, rated voltage: 250 V, pitch: 5.08 mm, no. of positions: 8, type of connection: Screw connection
1808874	MSTBC 2,5/ 8-ST-5,08	Plug component, nominal current: 12 A, rated voltage: 320 V, pitch: 5.08 mm, no. of positions: 8, type of connection: Crimp connection
1809569	MSTBC 2,5/ 8-STZ-5,08	Plug component, nominal current: 12 A, rated voltage: 320 V, pitch: 5.08 mm, no. of positions: 8, type of connection: Crimp connection
1769078	MSTBP 2,5/ 8-ST-5,08	Plug component, nominal current: 12 A, rated voltage: 250 V, pitch: 5.08 mm, no. of positions: 8, type of connection: Screw connection
1781043	MSTBT 2,5/ 8-ST-5,08	Plug component, nominal current: 12 A, rated voltage: 250 V, pitch: 5.08 mm, no. of positions: 8, type of connection: Screw connection
1824188	MSTBU 2,5/ 8-STD-5,08	Plug component, nominal current: 12 A, rated voltage: 320 V, pitch: 5.08 mm, no. of positions: 8, type of connection: Screw connection
1831375	MSTBVK 2,5/ 8-ST-5,08	Plug component, nominal current: 12 A, rated voltage: 320 V, pitch: 5.08 mm, no. of positions: 8, type of connection: Screw connection
1792304	MVSTBR 2,5/ 8-ST-5,08	Plug component, nominal current: 12 A, rated voltage: 250 V, pitch: 5.08 mm, no. of positions: 8, type of connection: Screw connection
1792812	MVSTBW 2,5/ 8-ST-5,08	Plug component, nominal current: 12 A, rated voltage: 250 V, pitch: 5.08 mm, no. of positions: 8, type of connection: Screw connection
1917969	QC 0,75/ 8-ST-5,08	Plug components, 5.08 mm pitch, color: green, no. of positions

MSTBV 2,5/ 8-G-5,08



		8, dimension a 35.56 mm
1883310	QC 1/ 8-ST-5,08	Plug component, nominal current: 10 A, rated voltage: 250 V, pitch: 5.08 mm, no. of positions: 8, type of connection: Insulation displacement connection QUICKON
1826348	SMSTB 2,5/ 8-ST-5,08	Plug component, nominal current: 12 A, rated voltage: 250 V, pitch: 5.08 mm, no. of positions: 8, type of connection: Screw connection
1853078	TMSTBP 2,5/ 8-ST-5,08	Plug component, nominal current: 12 A, rated voltage: 250 V, pitch: 5.08 mm, no. of positions: 8, type of connection: Screw connection
1833878	UMSTBVK 2,5/ 8-ST-5,08	Plug component, nominal current: 12 A, rated voltage: 320 V, pitch: 5.08 mm, no. of positions: 8, type of connection: Screw connection
1873029	ZFKK 1,5-ICV-5,08	Modular terminal blocks with plug entry, cross section: 0.2 - 1.5 mm ² , width: 5.1 mm, color: gray

► Address

PHOENIX CONTACT GmbH & Co. KG
Flachsmarktstr. 8
32825 Blomberg
Germany
Phone +49 5235 3 00
Fax +49 5235 3 1200
<http://www.phoenixcontact.com>
Phoenix Contact
Technical modifications reserved;